

Mental Health/Criminal Justice Collaborative Programs

Robert Butkiewicz MA, LPC
Criminal Justice Services Supervisor
Kalamazoo Community Mental Health and Substance
Abuse Services

Criminal Justice Context

- 10+ police jurisdictions
- District Court probation (misdemeanors)
- Circuit Court probation/parole
- 500 + bed jail (13-15 thousand bookings a year)
- Office of Community Corrections (pretrial supervision)
- Prisoner Re-entry

Sequential Intercept Model

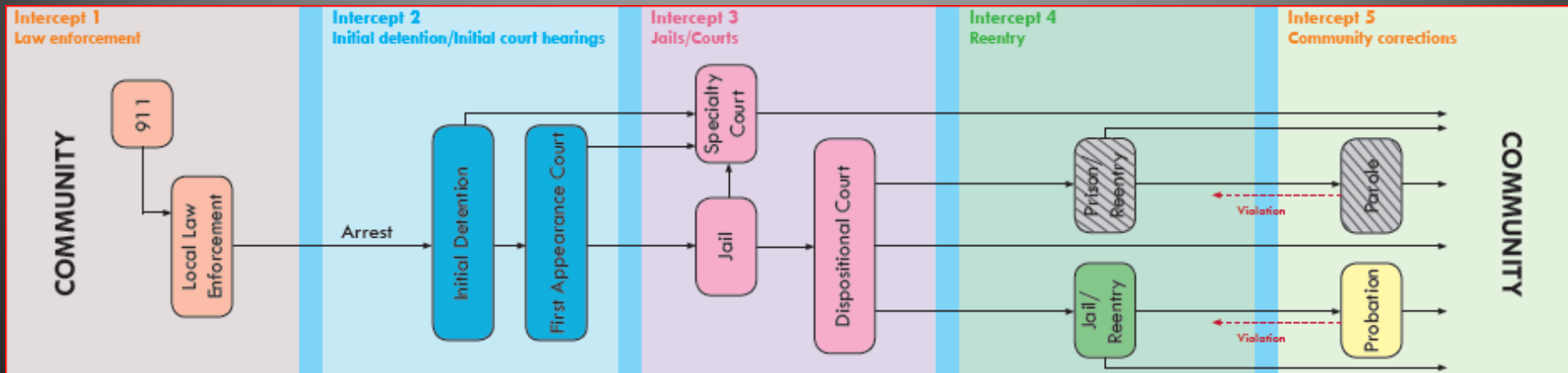

Intercept 1: Law Enforcement

- Co-responding (cmh/police)
- Co-location of police at emergency rooms
- Crisis Intervention Team (CIT)
- Crisis Negotiation Team
- Emergency Mental Health Units
 - MCR, ACT, EMH

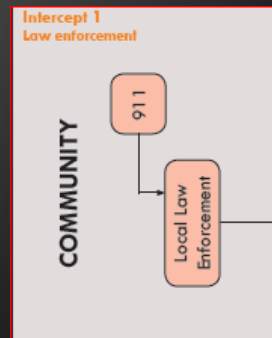

Co-responding unit

- Non-urgent police response
- Great concept!
- Hard to implement with multiple departments!
- Builds lasting relationships and understanding
- Great training opportunity

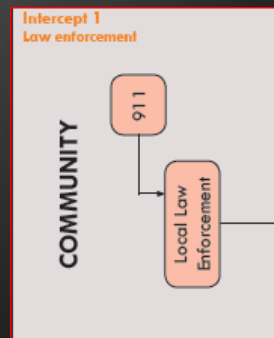

Co-location of police with ER

- Records pre-booking activity
- Fosters relationships
- Encourages law enforcement to bring consumers to ER for pre-booking jail diversion
- Used grant funds to seed

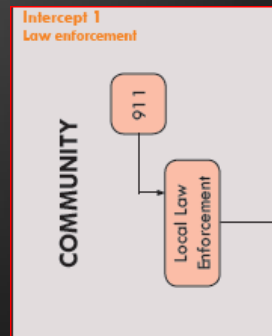

What is CIT

- A form of Specialized Police Response Team
- Crisis Intervention Team (CIT)
- CIT is a program that includes
 - Community collaboration
 - CIT coordinator and liaisons

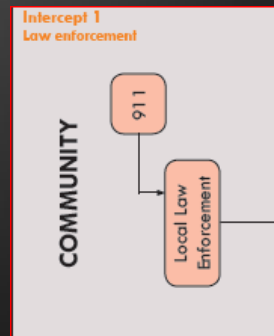

Crisis Intervention Team Training

- Large commitment of police training expenses
- No national standards
- 40 hour basic training
- 8 hour yearly in-service
- 8-40 hour dispatch training
- 8-40 hour CIT for Youth training

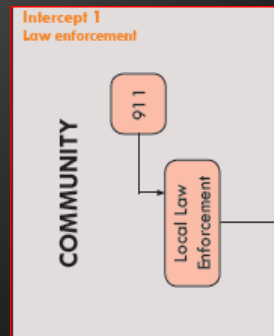

Kalamazoo CIT Training

- 40 hour training
 - 13-15 speakers
 - 2 locations
 - 8-10 role players
 - 4-6 safety officers
 - 2 consumer groups
- CIT for Youth
- In-service Training

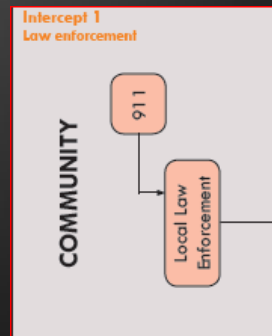

Training is the **EASY** part

- CIT must have champions
- CIT program coordinator
- CIT liaisons
- Development of data collection, analysis, and distribution
- Newsletters, website development
- Continued funding
- Community awareness

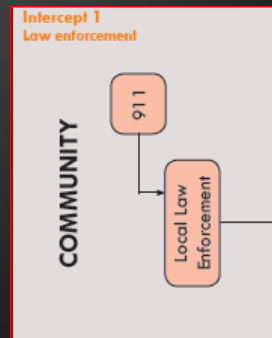

Crisis Negotiations Team

- Formerly called Hostage Negotiations Team
- Mental Health works as consultants not negotiators
- Becoming standard practice
- Can provide crucial information

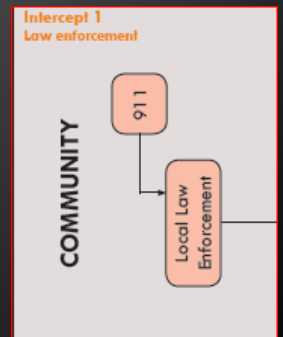

Intercept 2: Initial Detention/Court

- Secant “Interceptor” Project
- Jail Clinician

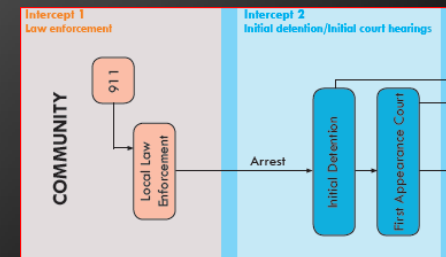
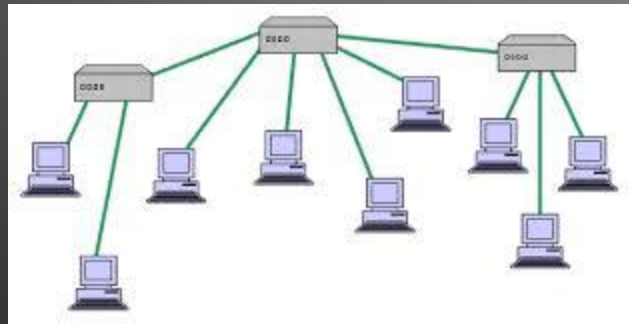

Secant “**Interceptor**” program

- Computerized cross referencing application
- Early identification of consumers
- Jail bookings and release
- Up-coming court dates
- Reporting information

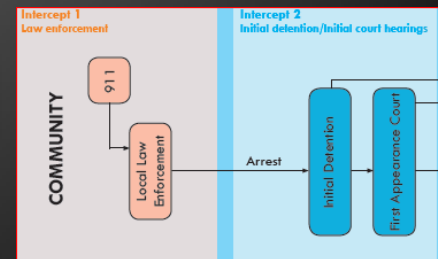

Jail Clinician

- Mental health and suicide screenings
- Not based on “consumer” status
- Referrals from all stakeholders
- Housing linkage
- Post-booking jail diversion
- Early identification of consumers
- Release planning starts immediately

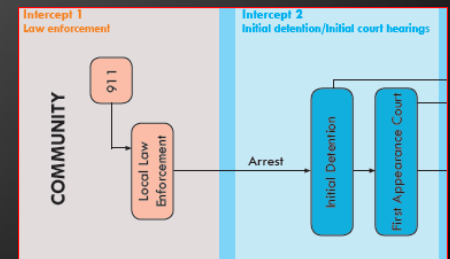

Intercept 3: Jail/Courts

- Mental Health Recovery Court
- Young Adult Diversion Court
- Sobriety Court, 4 Drug Courts, DV docket
- Jail Clinician
 - On-going Mental Health/Suicide Risk Screening
 - **Re-entry planning**
 - Initiation of psychiatric medications

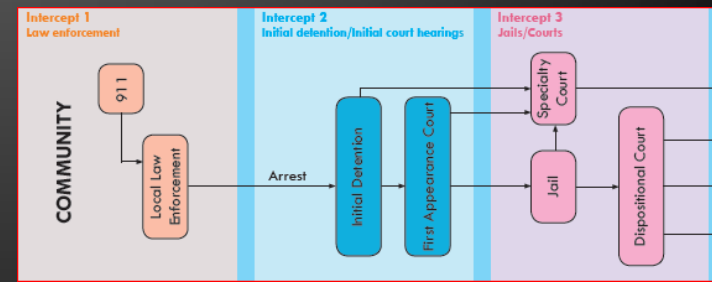

Intercept 4: Re-entry

- Prisoner Re-entry
- Jail Clinician
 - Linking or re-linking to services
 - Coordinating with natural supports
 - No questions asked follow med appointments

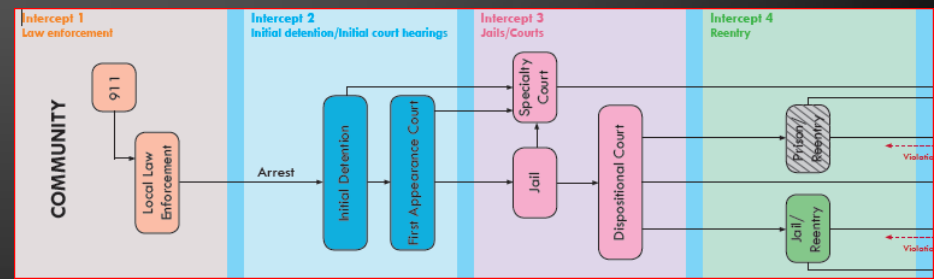

Intercept 5: Community Corrections

- Placement of staff in Circuit Court Probation/Parole, District Court Probation, Office of Community Corrections
- Liaison to Drug Court

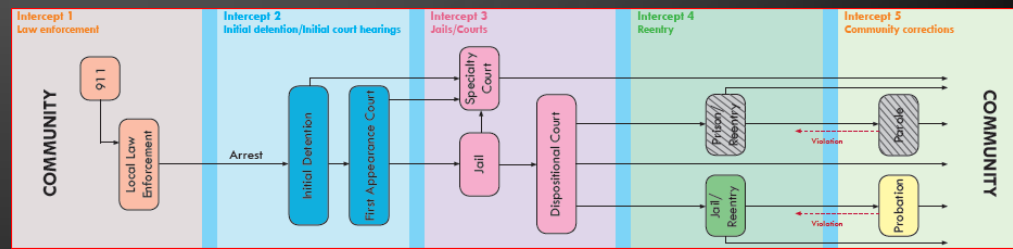

?’s